



# Product Specification

10/2015

---

**Product** TFT LCD Display

**Mode** APT TFT850C

**Abbreviation** 850C

---

**Client**

**Customer**

**audit**

---

**Supplier** Ealybike

**Email** info@etalbike.it

---

## 1. Product Name

- ✧ TFT LCD display
- ✧ Model : APT TFT 850C

## 2. Suppliers

- ✧ Tianjin APT Science and Technology Co., Ltd.

## 3. Electrical Parameters

- ✧ 3.2inch IPS screen
- ✧ 24V/36V/48V battery supply
- ✧ Rated operating current : 40mA
- ✧ Max operating current : 100mA (36V battery, with USB equipment changed)
- ✧ USB changing port : 5V 500mA
- ✧ Off leakage current < 1uA
- ✧ Max output current to controller : 100mA
- ✧ Operating temperature : -20~70°C, Storage temperature : -30~80°C

## 4. Dimensions & Material

- ✧ Product shell is ABS, transparent window is made with high strength Acrylic.
- ✧ Dimensions : host/L92mm\*W60mm\*H14mm



## 5. Features

- ✧ Suitable for low temperature, Max -20°C.
- ✧ High-contrast 3.2inch IPS colorful matrix screen.
- ✧ Ergonomic external button design, easy to operate.
- ✧ **Speed display** : AVG SPEED, MAX SPEED, SPEED(Real-time).
- ✧ **Kilometer / Mile** : Can be set according to customers' habits.
- ✧ **Smart battery indicator** : Provide a reliable battery indicator.
- ✧ **9-level Assist** : 3-level/5-level/9-level optional.
- ✧ **Mileage indicator** : Odometer/Trip distance/ Clock/ Riding time.
- ✧ **Power indicator** : real time power indicator, digital or analog.
- ✧ **Error code indicator.**
- ✧ **Software upgraded** : Software can be upgraded through UART.
- ✧ **USB charging port** : 5V/500mA

## 6. TFT screen instructions

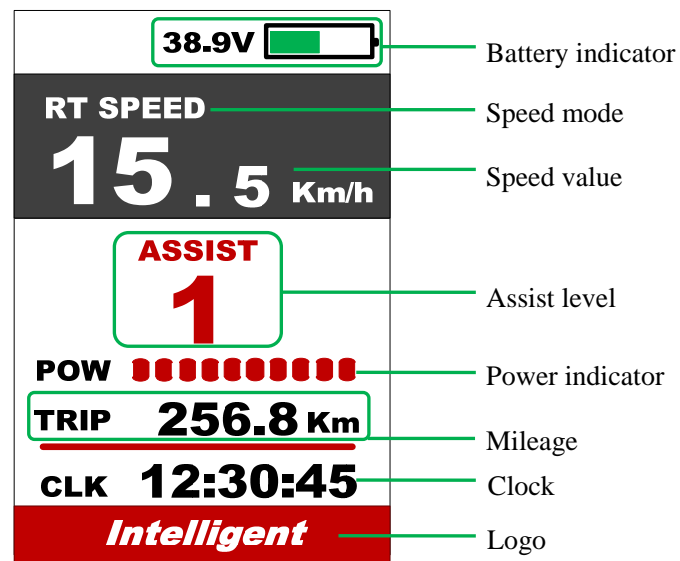

## 7. Functional Description

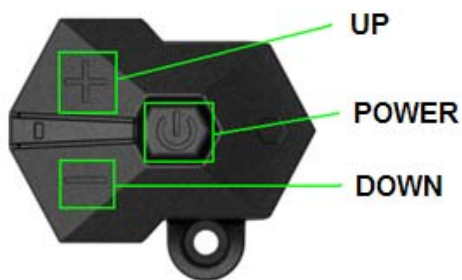

### 7.1 Power On/Off

Press and hold **Power** button for 1 second can turn on/off the display. The Display can automatically shut down when there is no operate & ride for X minutes (X could be 0~9) .

\*If the display has been set password power on, you need to input the right password before start.

### 7.2 Assist level operating

Short press **UP/DOWN** button can change the assist level. Top assist level is 5, 0 for neutral. Level quantities can be adjusted according to the customer requirements.

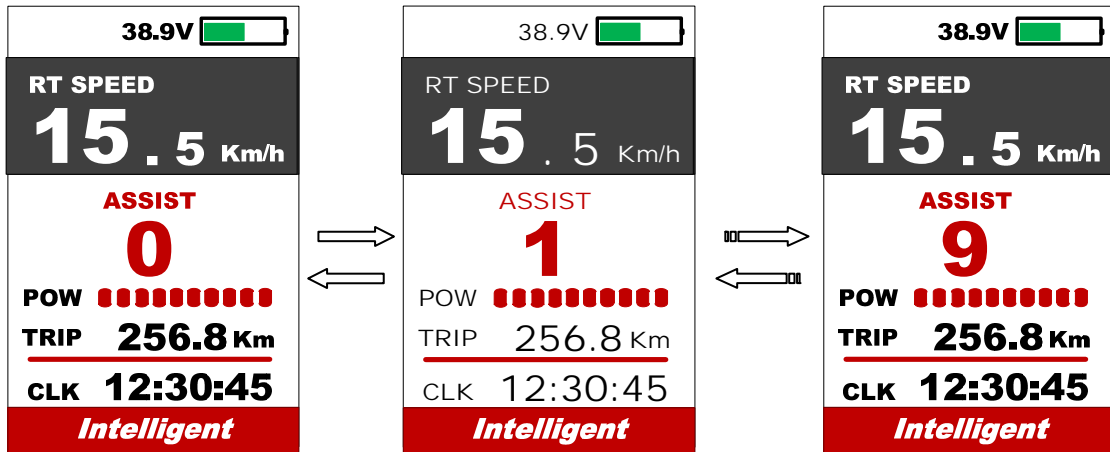

### 7.3 Speed & Mileage mode switch

Short press **POWER** button can change the speed and mileage mode, AVG Speed->MAX Speed->RT Speed-> Trip->ODO-> Time.

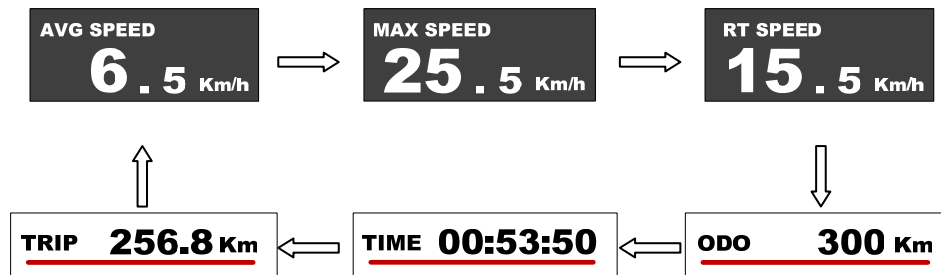

\*\*If there is no operation for 5 seconds, display will return Speed (Real-Time) display automatically.

### 7.4 Headlight/backlight On/Off

Press and hold **UP** button for 1 second can turn on/off the headlight, and the screen will switch to the corresponding mode.

\*The motor does not work when the battery voltage is low, Display still can keep the headlight on for a while when E-bike is in riding.



\* For safety reasons, display can't get into MENU when riding.

\* Display will quit MENU when start riding.

The order of parameters are as follow.

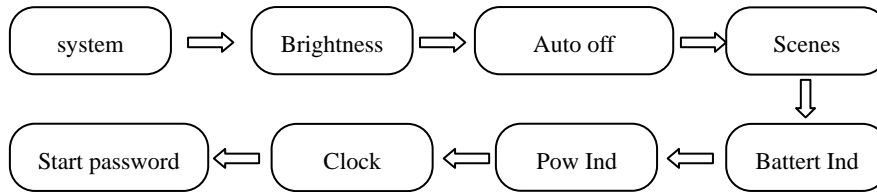

**8.1 System** : Press Up / Down button to switch between Metric / Imperial.

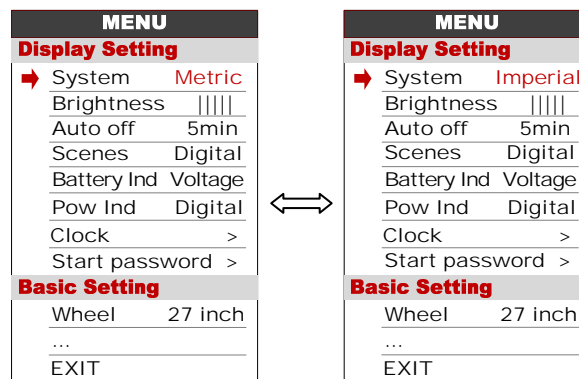

**8.2 Brightness** : Press Up / Down button to change the brightness of the backlight, | is darkness, ||||| is brightness

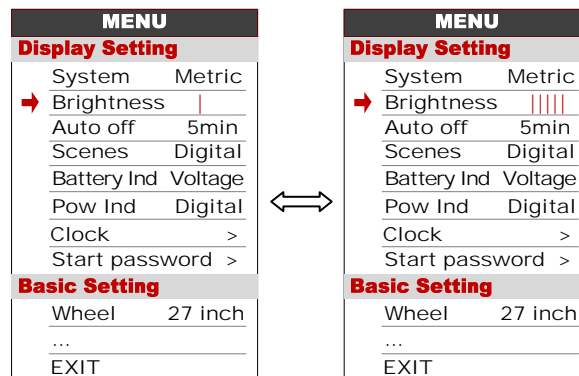

**8.3 Auto off** : Press UP/DOWN button to change the auto power off time, from 1 to 9, the number represent time (minutes) to shutdown, default value is 5 minutes.

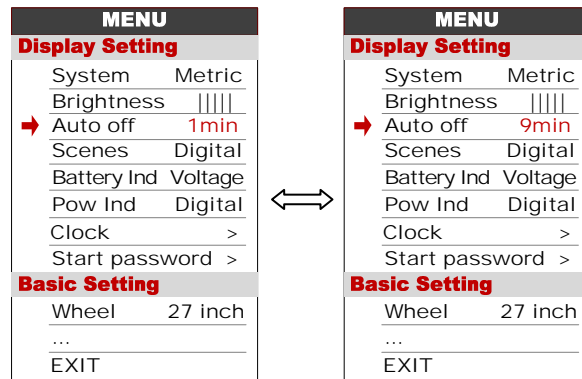

**8.4 Scenes** : Press UP/DOWN button to change the scenes, Digital / Analog.

\*Display only support Digital scenes for now, Analog scenes will be supported for future.

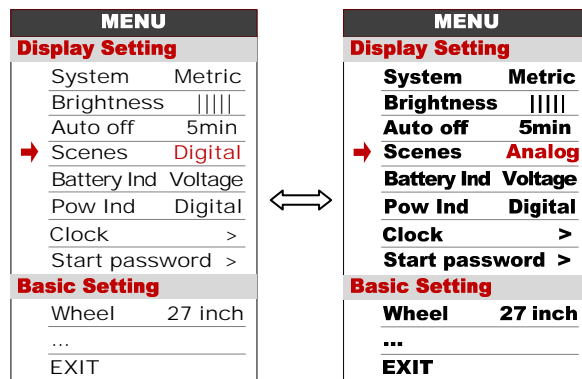

**8.5 Battery Ind** : Press UP/DOWN button to change the battery indicator, Voltage / Percentage / OFF.

\*Accurate percentage needs communication with battery.

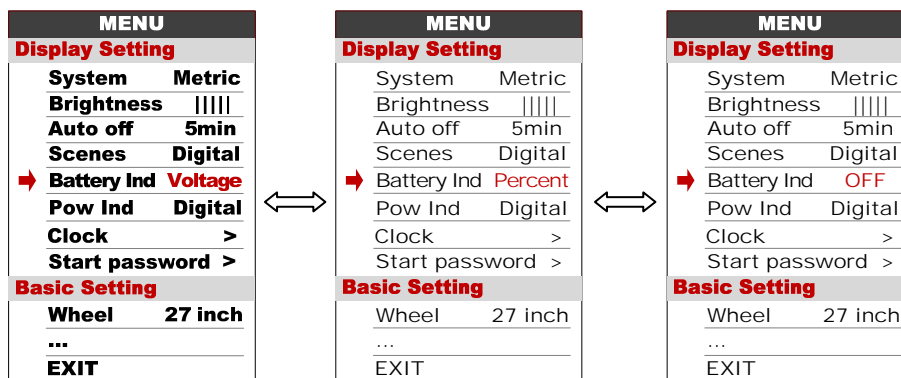



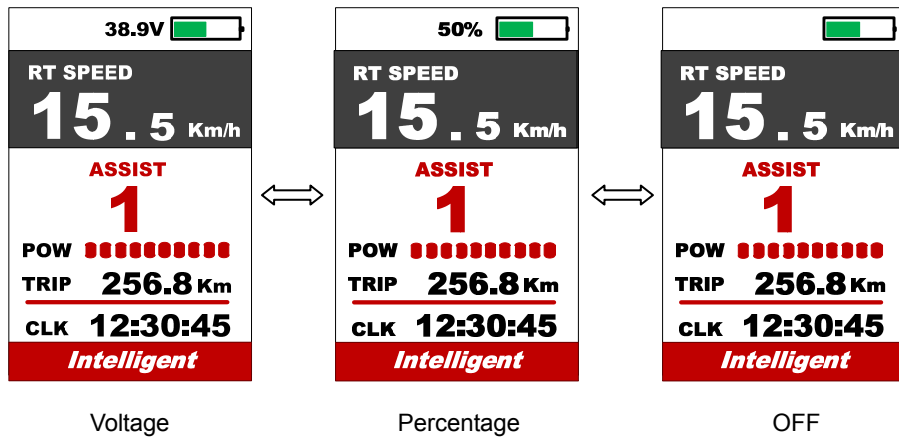

**8.6 Pow Ind** : Press UP/DOWN button to change the Power indicator, Analog / Digital.

\* This data represent power output of the battery (not motor).

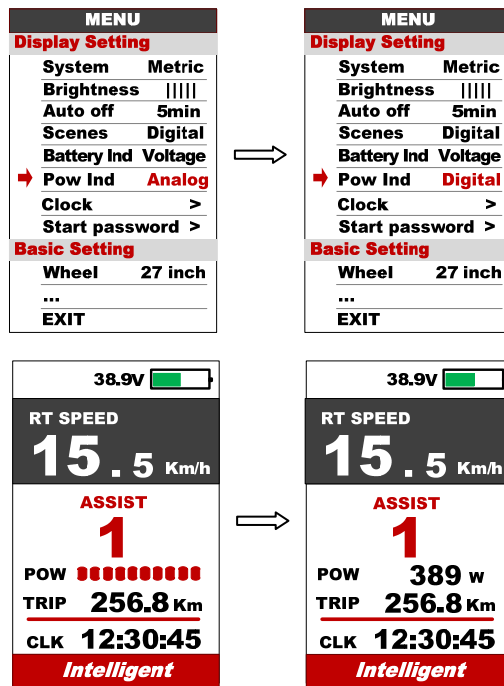

**8.7 Clock** : Clock setting, press POWER button get into the clock setting menu, press UP/DOWN button to set Year/Month/Day/Hour/Min/Sec.

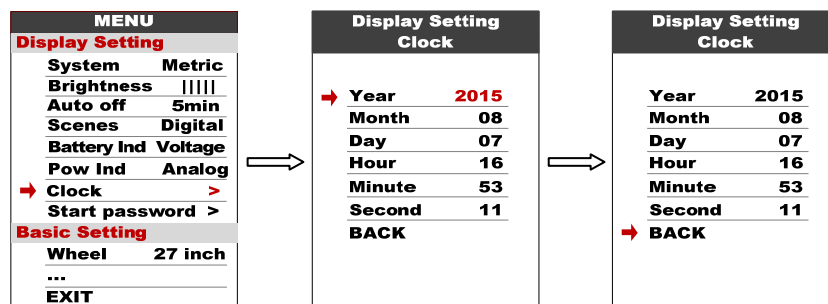

**8.8 Start password** : Press POWER button get into the password setting menu. If you had set Start input **ON**, you must input right password before power on, password is accorded to your setting.

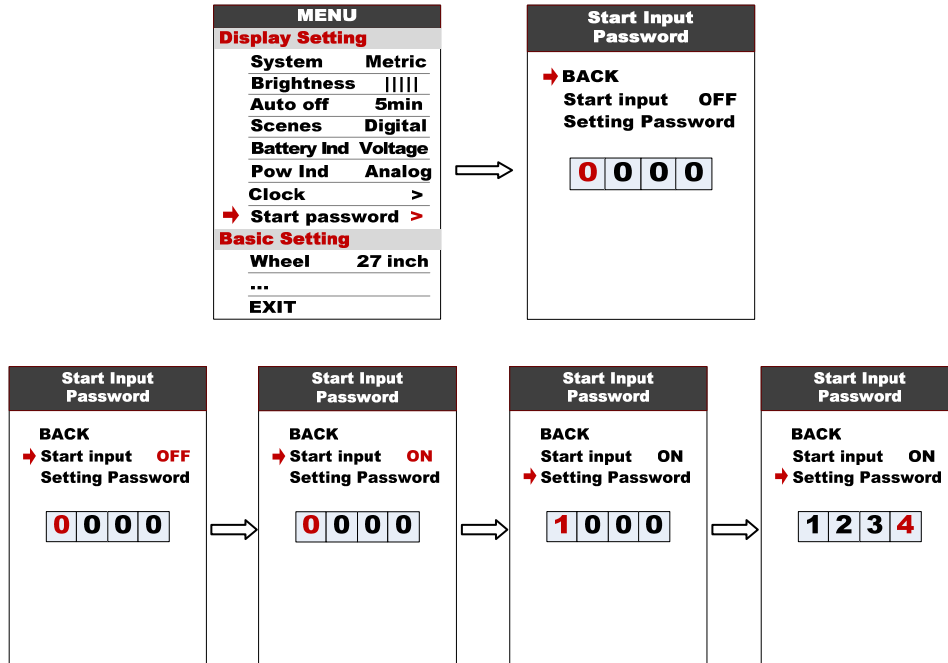

You need to input the right password before start with 30 seconds, display will power off automatically if the password was wrong.

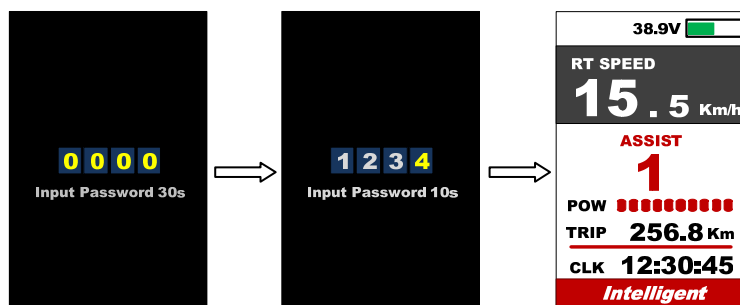

### Basic Setting

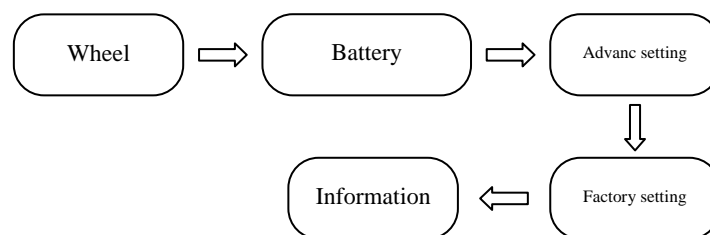

\*Press DOWN button to move the red arrow to **Wheel**, press POWER button can show all items of the Basic Setting.

**8.9 Wheel :** Press UP/DOWN can change the wheel setting, optional wheel diameter is 16/18/20/22/24/26/27/27.5/28/29/30/31 inch, 51cm~255cm represent wheel circumference (this needs controller support).

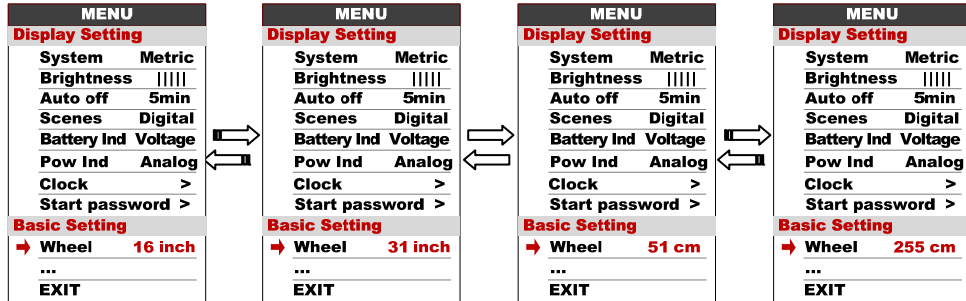

**8.10 Battery :** Press UP/DOWN will change battery voltage setting, optional value is 24V/36V/48V/UBE, UBE means user define value.

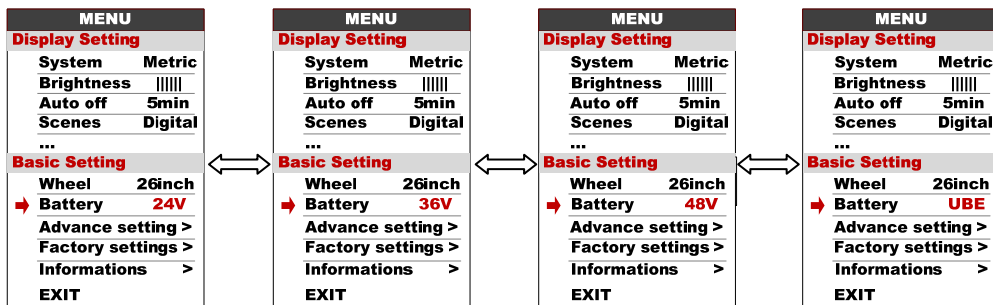

**8.11 Advance setting :** Press POWER button can get into the advance setting menu, default password is '1919'.

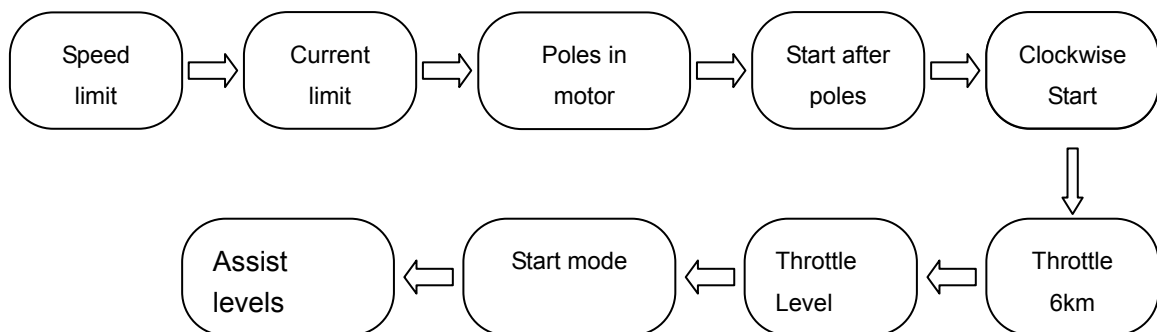
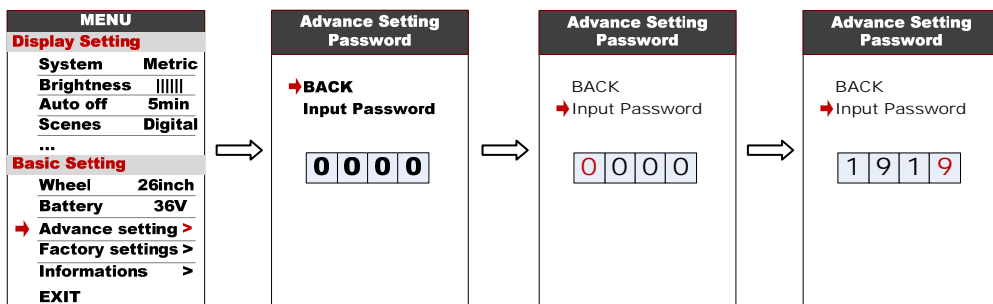

**8.12 Speed limit** : Press UP/DOWN will change speed limit, range 10km/h~45km/h.  
Default value is 25km/h.

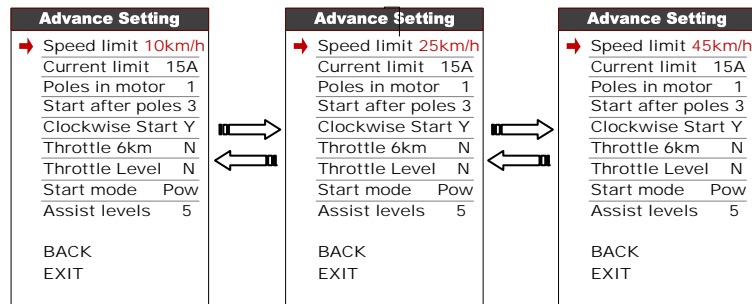

**8.13 Current limit** : Press UP/DOWN will change current limit, range 6A~50A. Default value is 15A.

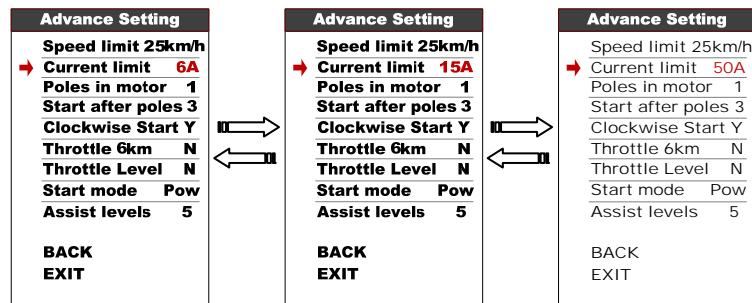

\*Speed limit and current limit are restricted by controller and motor.

**8.14 Poles in motor** : Magnetic poles inside the motor, press UP/DOWN will change pole number, range 1~6. Default value is 1.

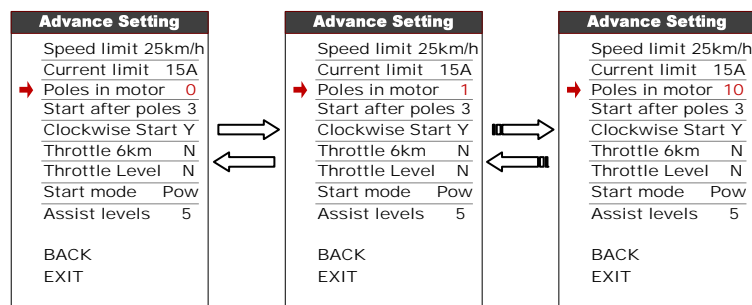

**8.15 Start after poles** : How many poles (speed sensor) need to be detected by controller before starting motor. Default value is 3.

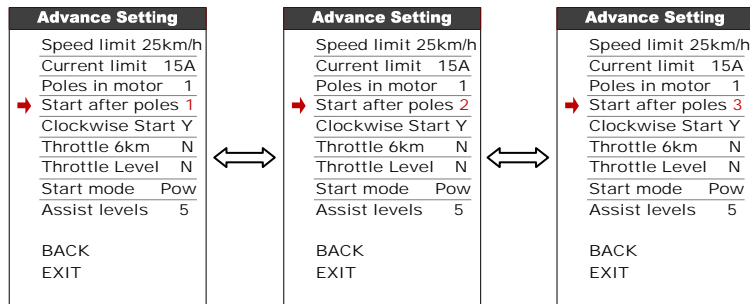

**8.16 Clockwise start** : This parameter represent speed sensor turn direction, default value is Y (forward).

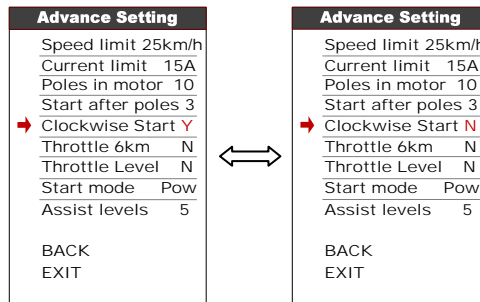

**8.17 Throttle 6KM** : this parameter can set the throttle function, N represent max speed, Y represent 6Km.

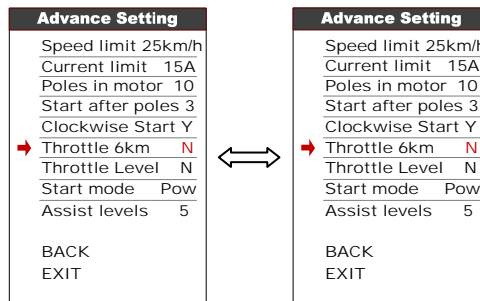

**8.18 Throttle Level** : This parameter is functional when Throttle 6KM set N, Press UP/DOWN will change Y/N, N represent Throttle start max speed, Y represent throttle's speed is accorded to the assist level.

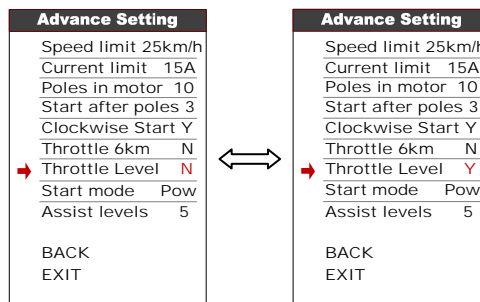

**8.19 Start mode** : Pow/ECO/STD represent Power/ECO/Standard, Power mode means use maximum current when speed up (default), ECO mode means use minimum current.

\*This function is optional, may not supported by each mode.

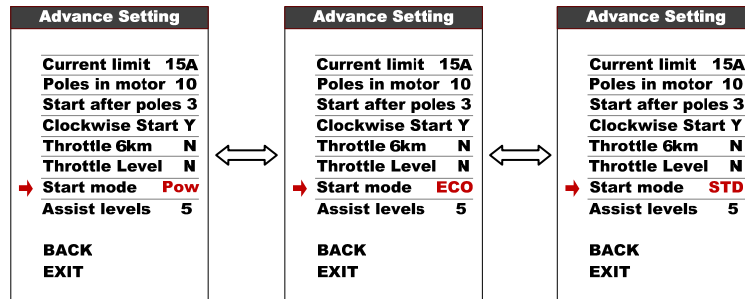

**8.20 Assist levels** : This parameter can customize assist levels, options are 3/5/9/UBE, UBE represent factory default settings.

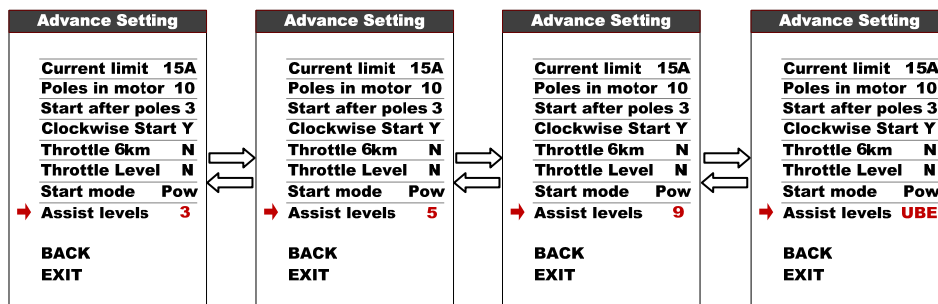

**8.21 Factory setting** : Press POWER button enter Restore Factory settings item, set YES will restore all parameter to factory settings.

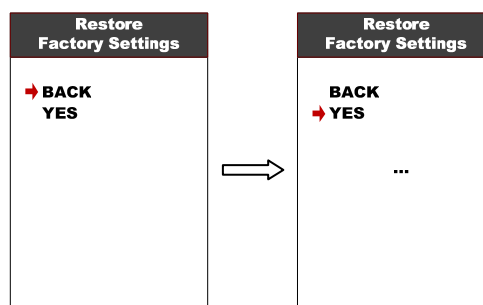

**8.22 Information** : Show information of the E-bike.

Information	
<b>Speed</b>	
AVG	15.4 Km/h
Max	32.4 Km/h
<b>Mileage</b>	
Trip	9999.9 Km
ODO	99999.9 Km
Range	59.9 Km
→ BACK Product Infor Battery Infor	

**8.23 Product info** : Get into this item can show hardware version software version...

Information	Product Information
<b>Speed</b> <b>AVG 15.4 Km/h</b> <b>Max 32.4 Km/h</b> <b>Mileage</b> <b>Trip 9999.9 Km</b> <b>ODO 99999.9 Km</b> <b>Range 59.9 Km</b> → <b>BACK</b> <b>Product Infor</b> <b>Battery Infor</b>	<b>Version</b> Hardware ver. 2.0 Software ver. 1.0A-V1 <b>Product Information</b> Date Serial No → <b>EXIT</b>

**8.24 Battery info** : Get into this item can show all information of battery, including Voltage, Capacity, Cycle times, Health, Temperature of battery, Remaining Capacity, Full Charge Capacity, Initial Capacity.

\*These information needs to be supported by battery communication.

Information	Battery Information
<b>Speed</b> <b>AVG 15.4 Km/h</b> <b>Max 32.4 Km/h</b> <b>Mileage</b> <b>Trip 9999.9 Km</b> <b>ODO 99999.9 Km</b> <b>Range 59.9 Km</b> → <b>BACK</b> <b>Product Infor</b> <b>Battery Infor</b>	<b>Voltage 42.0V</b> <b>Capacity 100%</b> <b>Cycle times 5</b> <b>Health 95%</b> <b>Temperature 35 °C</b> <b>Remaining Capacity 11400mAh</b> <b>Full Charge Capacity 11400mAh</b> <b>Initial Capacity 12000mAh</b> → <b>EXIT</b>

## 9. Error Code define

850C can show warning message,  icon shows on the screen, and show error code at the bottom of the screen, error code from 01~07, definition see the table below.

Error Code	Error description	Handle
01	Communication Error	Check the cable connection
02	Controller protection	Check three-phase power line.
03	three-phase power error	Check three-phase power line connection
04	Battery low	Charge the battery

05	Brake error	Check the brake connection.
06	Throttle error	Check turn to connect.
07	Hall error	Check the hall connection
08-99	Reserved	Please contact the manufacturer for error definitions

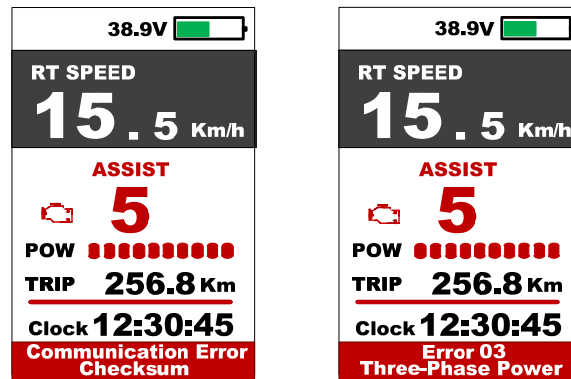

## 10. Assembly instructions

Please pay attention to the screw's torque value, damaged caused by excessive torque is not within the scope of the warranty.

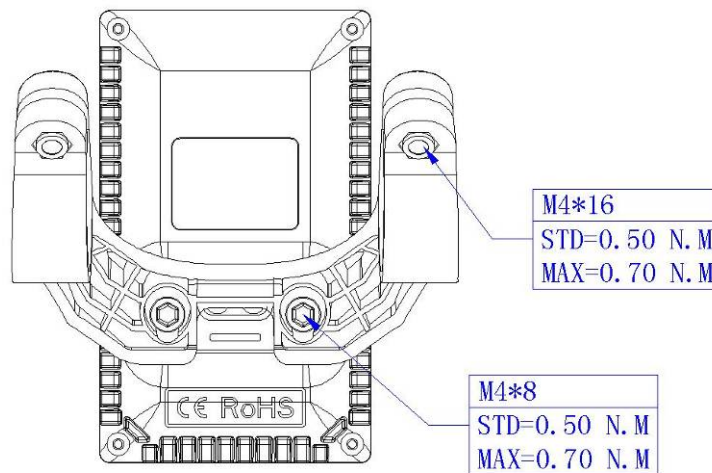



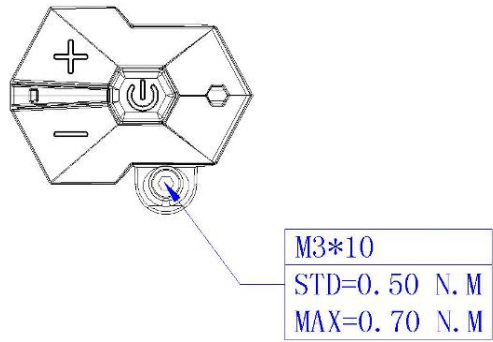

There are 2 directions for the clamp installation, forward or backward.



Clamps suit for 3 size of handlebar, 31.8mm, 25.4mm, 22.2mm, there are transfer rings for 25.4mm and 22.2mm, transfer ring must be assembled with the special directions, pay attention to the green arrow below.

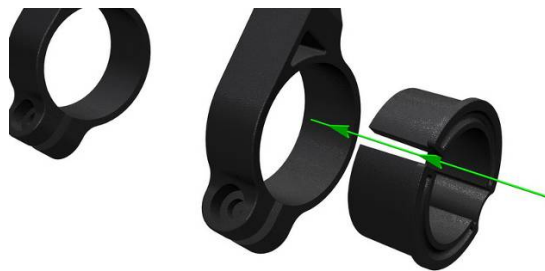

## 11. Connector descriptions

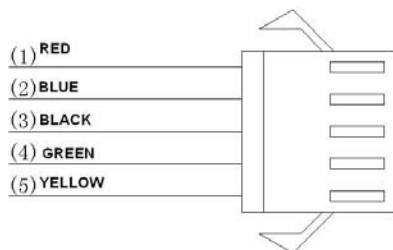

- 1、 Red wire : Anode(24v/36v/48V)
- 2、 Blue wire : Power cord to the controller
- 3、 Black wire : GND
- 4、 Green wire : RxD (controller -> display)
- 5、 Yellow wire : TxD (display -> controller)

## 12. Assist level instructions

Assist level can be customized, the highest level is 9, common used assist level see the table below:

3 level	5 level	9 level	
0		0	No power assist
	1	1	
		2	
1	2	3	
		4	
	3	5	
2		6	
	4	7	
		8	
3	5	9	

## 13. Certification

CE / IP65 (water proof) / ROHS.